

ICS Sistem

ICS Cam Balkon Sistemlerinde kullanılan tüm aksesuar ve malzemelerin üzerinde kalite güvencesi olan BKS logosu bulunmaktadır.

ICS Cam Balkon Sisteminde kullanılan alüminyum profiller, BKS Katlanır Sistemleri'ne özgü dizaynı ile özel olarak üretilmiş, kalitesi kanıtlanmış, tescilli ürünlerdir.

ICS Cam Balkon Sistemlerindeki bazalar 30 mm cam kullanımına uygun olarak üretilmiştir.

ICS Cam Balkon Sistemlerinde; Pres, Eloksal, Bronz olarak standart renkler mevcuttur.

ICS Cam Balkon Sistemlerinde teker bağlantı ayakları oksitlenmeye karşı paslanmaz çelikten üretilmiştir.

ICS Cam Balkon Sistemleri; istenildiğinde üstten taşımalı, istenildiğinde alttan taşımalı olarak monte edilme imkanına sahiptir. Her bir kanatta 8 rulman vardır. Sistem üstten monte edilirse; üstteki 4 rulman taşıyıcı görevi yapar, alttaki 4 rulman kılavuzlama yapar. Sistem alttan monte edilirse; alttaki 4 rulman taşıyıcı görev yapar, üstteki 4 rulman kılavuzlama yapar.

ICS Cam Balkon Sisteminde dik ve yatay profillerin bağlantısında dış yüzeyden gözle görülmeyen plastik aparat kullanılarak görsel bütünlüğü sağlanmıştır.

ICS Cam Balkon Sisteminde dik profiller arasında miknatıslı fitille yalıtım sağlanmaktadır. Ayrıca dikey kullanıma sahip profillerde bulunan kanallar sayesinde istenildiği takdirde miknatıslı fitille beraber kıl fitil kullanımına da olanak sağlamaktadır.

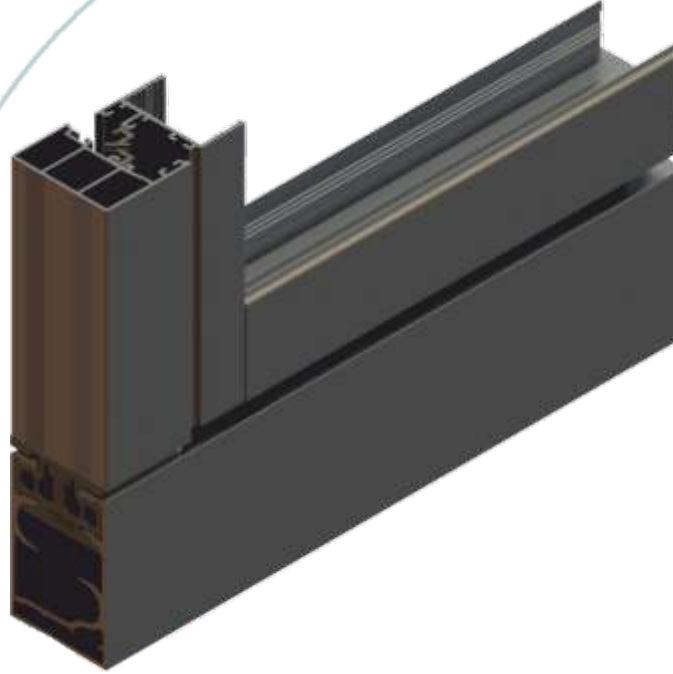

ICS Systems

All accessories and materials used on ICS Glass Balcony System have got BKS logo as quality assurance as.

The aluminum profiles used in the ICS glass Balcony System, are proprietary products with proven quality and specially produced with unique design of BKS Folding Glass Systems

The frame profile used in ICS Glass Balcony Systems has been designed and manufactured with two- channelled enabling conveyance of double bearings in each pillar.

The base profiles of ICS Glass Balcony Systems has been produced for 30 mm glasses.

In ICS Glass Balcony Systems are available standard colors as: Press, Anodized, Bronze.

The Wheel support brackets of BKS Glass Balcony Systems have been made of stainless steel against corrosion.

ICS Glass Balcony Systems can be mounted with a particular of top-conveyance and bottom-conveyance when deemed necessary.

There are 8 bearings in each wing.

If the system is mounted from the top, 4 bearings at the top assume conveyance, and 4 bearings at the bottom assume guidance.



If the system is mounted from the bottom, 4 bearings at the bottom assume conveyance, and 4 bearings at the top assume guidance.

For connection of vertical and horizontal profiles

in ICS Glass Balcony System visual integrity is provided by the way using plastic apparatus invisible from the outer surface.

Has provided system insulation using of magnetic seals between vertical profiles on ICS Glass Balcony System. Furthermore, it is possible to use even hair seals instead of magnetic seals, thanks to channels inside of vertically proposed profiles.













ICS SİSTEM

DAMLALIK PROFİLİ W.6288.00		ICS CAM ARA PROFİLİ 30 MM ELOKSAL W.5004		ICS CAM BALKON SİSTEMİ NUMUNESİ W.5000	
EYEDROPPER PROFILE		ICS INTERMEDIATE PROFİL 30 MM		ICS DOUBLE GLAZED SYSTEM SAMPLE	
ICS BAĞLANTI PLASTİĞİ W.5100		ICS 135 DERECE DİKİME PROFİLİ ELOKSAL W.5005		ICS YAN DİKİME PROFİLİ ELOKSAL W.5001	
ICS PLASTIC CONNECTION CAP		ICS PROFILE 135 DEGREE		ICS SIDE COLUMN PROFILE	
ICS PLASTİK KİLİT ÜST HALKALI W.5110		BKS KASA PROFİLİ (ALT&JUST) W.6218.00		ICS KÖŞE DİKİME PROFİLİ ELOKSAL W.5002	
ICS PLASTIC LOCK WITH RING BOTTOM-TOP		BKS FRAME PROFILE (BOTTOM & TOP)		ICS ANGLE PROFILE	
YAN DİKİME PROFİLİ W.5500		BKS DAMLALIKLI KASA PROFİLİ ALT W.6118.00		ICS CAM BAZA PROFİLİ 30 MM ELOKSAL W.5003	
SIDE COLUMN PROFILE		DROPPER LOWER FRAME PROFILE		ICS BASE PROFILE 30 MM	

BKS-KCS DÜZ TEKER (METAL PİMLİ) W.6285.01		ALÜMİNYUM KİLİTLİ TEKER W.6291.02		ICS 90/135, YAN DİKME MİKNATISLI FİTİL (50 MM) W.5501	
BKS-KCS PLAIN WHEEL (METAL PIN) W.6271.00		ALUMINIUM PLAIN WHEEL W.6219.00		ICS SIDE COLUMN,90 AND 135 DEGREE MAGNET SEAL (50M) W.6247	
BKS-KCS ALT-ÜST MENTEŞE W.6271.00		BKS-KCS KİLİTLİ TEKER PASLANMAZ PİMLİ W.6220.00		DEKORATİF KULP W.6289.00	
BKS-KCS HINGE BOTTOM AND UP W.6244.00		BKS-KCS LOCKING WHEEL WITH STAINLESS PIN W.6284.00		DECORATIVE HANDLE W.6292.01	
YANDIKİME APARATI W.6244.00		BKS-KCS DÜZ TEKER PASLANMAZ PİMLİ W.6284.00		YAĞMUR ÇITASI W.6289.00	
SIDE COLUMN EQUIPMENT W.6265.45		BKS-KCS PLAIN WHEEL WITH STAINLESS PIN W.6284.00		RAIN STREAMER W.6292.01	
BKS STOPLAMA (45 MM) W.6265.45		BKS-KCS KİLİTLİ TEKER (METAL PİMLİ) W.6284.00		ALÜMİNYUM DÜZ TEKER W.6292.01	
BKS STOPPER (45 MM) W.6265.45		BKS-KCS STAINLESS LOCKING WHEEL (METAL PIN) W.6284.00		ALUMINIUM LOCKED WHEEL W.6292.01	

ICS SİSTEM

BKS ÇIKIŞ AĞZI PLASTİĞİ/ALT W.6224.00		BKS-KCS-ANK FREN W.6221.00		MAFSALLI GÖNYE W.6240.00	
BKS OUTLET PLASTICS BOTTOM		BKS-KCS-ANK BRAKE		HINGED T-SQUARE	
BKS-KCS-ANK ALT MENTEŞE (PASLANMAZ) W.6287.01		BKS-KCS KIRLANGIÇ GEÇMELİ FREN W.6272.00		BAĞLANTI GÖNYESİ W.6233.00	
BKS-KCS-ANK BOTTOM HINGE (STAINLESS)		BKS-KCS DISCONNECTED PARE BRAKE		ANGLE IRON	
SABİT MENTEŞE W.6225.00		BKS-KCS LUX KİLİT ALT-ÜST W.6248.00		BKS-KCS-ANK LUX FREN ALT W.6222.01	
FIXED HINGE		KS-KCS LUX LOCK BOTTOM-TOP		BKS-KCS-ANK LUX BRAKE BOTTOM	
BKS KATLANIR KILAVUZLU ÇIKIŞ AĞZI SOL ÜST W.6243.01		BKS-KCS LUX KİLİT ALT-ÜST OTOM. W.6248.03		BKS-KCS-ANK LUX FREN ÜST W.6222.02	
BKS OUTLET COLLAPSIBLE GUIDED LEFT TOP		BKS-KCS LUX LOCK BOTTOM-TOP FOR AUTO		BKS-KCS-ANK LUX BRAKE BOTTOM	

4,5 mm BONCUKLU PLASTİK İP W.6001.00		SÜRME KİL FİTİL 67*1000 W.6710.00		BKS KATLANIR KILAVUZLU ÇIKIŞ AĞZI SAĞ ÜST W.6243.02	
4,5 PLASTIC BEAD ROPE		SLIDING SHUTTER HAIR SEAL 67*1000		BKS OUTLET COLLAPSIBLE GUIDED RIGHT TOP	
ANK-DRT-BRK LUX KİLİT ZİNCİRİ (KROM) W.6273.00		SİLİKON FİTİL (YAN DİKİME FİTİL) 50 MT (BEYAZ) W.6231.00		BKS OTOMATİK KATLANIR KILAVUZLU ÇIKIŞ AĞZI SOL ÜST W.6270.01	
ANK-DRT-BRK LUX LOCK CHAIN (CHROME)		SILICONE SEAL (SIDE COLUMN SEAL 50 MT (WHITE)		BKS OUTLET AUTOMATIC COLLAPSIBLE GUIDED LEFT TOP	
GÖMME KİLİT ZİNCİRİ (KROM) W.6274.00		SİLİKON FİTİL (YAN DİKİME FİTİL) 50 MT SİYAH) W.6231.00		BKS OTOMATİK KATLANIR KILAVUZLU ÇIKIŞ AĞZI SAĞ ÜST W.6270.02	
MORTISE LOCK CHAIN (CHROME)		SILICONE SEAL (SIDE COLUMN SEAL 50 MT (BLACK)		BKS OUTLET AUTOMATIC COLLAPSIBLE GUIDED RIGHT TOP	
KROM ZİNCİR (KROM) W.6276.00		SİLİKON FİTİL (YAN DİKİME FİTİL) 50 MT KAHVE) W.6231.00		SÜRME KİL FİTİL 67*1200 W.6712.00	
CHROME CHAIN (CHROME)		SILICONE SEAL (SIDE COLUMN SEAL 50 MT (BROWN)		SLIDING SHUTTER HAIR SEAL 67*1200	